

# **Mastermind LT<sup>TM</sup>**

User's Manual



RJM Music Technology, Inc.



# Mastermind LT™

## User's Manual

Version 3.1  
12/8/2016

RJM Music Technology, Inc.  
2525 Pioneer Ave.  
Suite 1  
Vista, CA 92081  
+1-760-597-9450  
email: [support@rjmmusic.com](mailto:support@rjmmusic.com)  
web: [www.rjmmusic.com](http://www.rjmmusic.com)

**Copyright © 2016 RJM Music Technology, Inc. All Rights Reserved**

**RJM and the RJM logo are registered trademarks of RJM Music Technology, Inc. RG-16, Amp Gizmo, Effect Gizmo, Rack Gizmo, Switch Gizmo and Mastermind LT are trademarks of RJM Music Technology, Inc. All other trademarks are the property of their respective holders.**

# Table of Contents

<b>Table of Contents</b> .....	<b>v</b>
<b>Introduction</b> .....	<b>1</b>
<b>Front Panel</b> .....	<b>3</b>
Front Panel Controls.....	3
Main Display.....	4
<b>Rear Panel</b> .....	<b>5</b>
Rear Panel Connections and Switches.....	5
<b>Basic Operation</b> .....	<b>6</b>
Preset Mode .....	6
IA Page.....	6
Programming a Preset.....	6
<b>MIDI &amp; Preset Setup</b> .....	<b>7</b>
Entering Setup Mode.....	7
Adding a Device.....	7
Assigning Program Changes.....	8
<b>Song and Setlist Mode</b> .....	<b>10</b>
Editing Songs.....	10
Editing Setlists .....	10
Using a Setlist.....	10
<b>Editing Button Pages</b> .....	<b>12</b>
Button Page Type.....	12
CCs and CC+FnSw Types .....	13
Device PC.....	13
Notes .....	14
Preset .....	14
<b>Expression Pedal</b> .....	<b>15</b>
The Mission Engineering SP1-RJM.....	15
Expression Pedal Setup.....	15
Setting Up The Expression Pedal Position Switch.....	16
<b>External Switches</b> .....	<b>17</b>
<b>Remote Mode</b> .....	<b>18</b>
<b>External MIDI Control</b> .....	<b>19</b>
Setlist=None.....	19
Setlist active, Bank=Song On .....	19
Setlist active, Bank=Song Off .....	19
Switch Control using CC Messages.....	19
<b>Other Special Features</b> .....	<b>21</b>
Function Switching a.k.a. Controlling Your Amp.....	21
Global Preset.....	21
Tap Tempo and MIDI Clock.....	21
Auto Tap .....	22
<b>Loading and Saving Settings to a USB Flash Drive</b> .....	<b>23</b>
Load Settings .....	23
Save Settings.....	23
<b>Connecting to a Computer</b> .....	<b>24</b>
Mastermind Editor .....	24
<b>Updating Firmware</b> .....	<b>25</b>

<b>Setup Mode Reference</b> .....	<b>26</b>
Text Entry .....	26
Main Menu .....	27
Edit Devices .....	28
Edit Device Menu.....	29
Edit Presets .....	30
Fn Switch Settings.....	30
MIDI Settings.....	31
System Functions Menu.....	31
Expression Pedal Menu .....	32
<b>Specifications</b> .....	<b>33</b>
<b>Mastermind LT MIDI Implementation Chart</b> .....	<b>34</b>

## Introduction

Thank you for purchasing the Mastermind LT MIDI controller! The Mastermind LT is designed to be low cost and compact, while still being extremely powerful and configurable.

The Mastermind LT includes a large feature list:

- 7 buttons, each with a multi-color indicator LED
- Large main LCD display that displays preset, song, and other status information
- Any button on the controller can be assigned to any function
- There can be up to 16 global button pages, each of which can be configured with its own full set of buttons
- Enough storage for 768 presets and 16 connected devices
- Song and setlist mode allows you to group presets in a way that makes the most sense for your performance. 1008 songs and 64 setlists can be defined by the user
- Each preset can also have its own local button page
- Each instant access button can send 20 additional MIDI messages
- Each preset can change the state of every instant access button on all 16 button pages
- Each preset can send program and bank changes to each device, plus also send up to 10 general MIDI messages
- Expression pedal inputs
- External switch input which can accept a 1 button or 2 button footswitch. External switches can be configured for any function that the built-in switches can
- USB "A" port allows the use of a USB flash drive for settings backup and firmware upgrades
- USB "B" port for connection to a PC or Mac. The Mastermind LT will show up as a MIDI device in the system and can be powered over the USB connection
- Phantom power capability when using a 7 pin MIDI cable
- MIDI Input jack, which allows the synchronized use of multiple Mastermind LT controllers on stage, or external control by other MIDI devices
- Built in editing allows the creation of button pages and defining MIDI messages (PC, CC and Note)
- Mac and PC editor software allows for faster and more comprehensive editing





## Front Panel

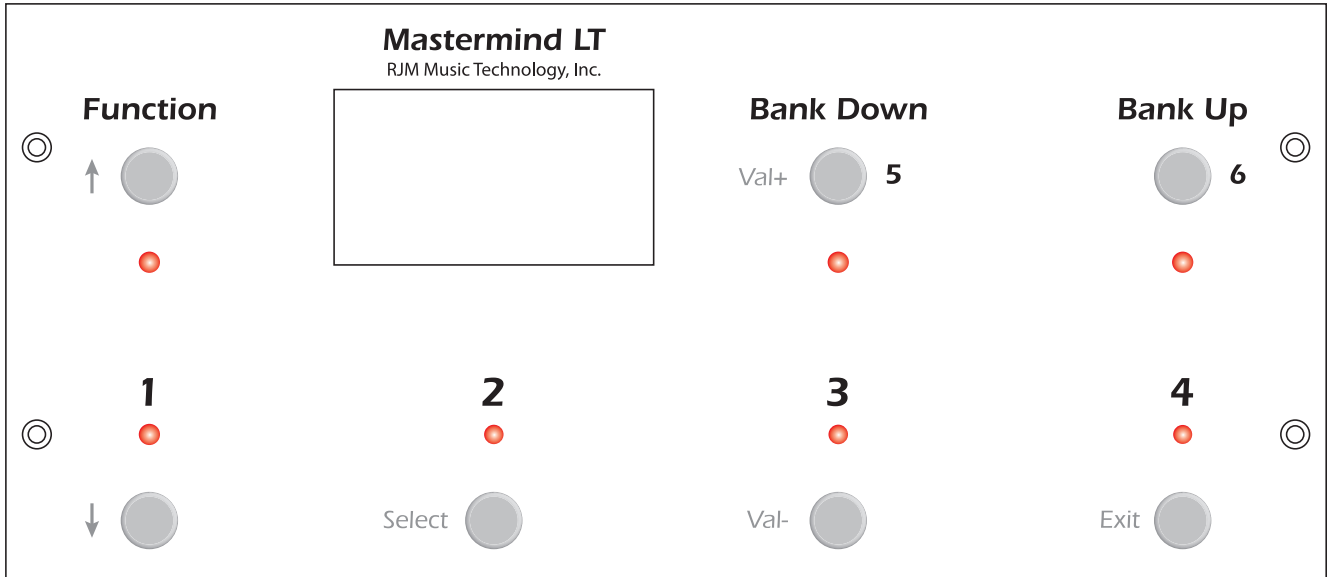

### Front Panel Controls

Each button on the front panel can have different functions depending on the current operating mode. In this section, we will only describe the button's main function. The other button functions will be described in subsequent sections of the manual.

**1 through 4** – These buttons select one of the four presets in the current bank. Each preset can send MIDI commands to all of your connected devices and also turn function switches on or off. Holding buttons **1** and **3** enters Setup Mode.

**Bank Up / Bank Down** –The 768 presets in the Mastermind LT are arranged in banks of 4, and these buttons allow you to select which bank of 4 you'd like to access. In Song and Setlist mode, these buttons select the next or previous song in the current setlist.

When selecting banks (or songs), the preset buttons (**1-4**) flash, indicating that you need to select a preset within the desired bank. The LT will remain on the previously selected preset throughout the bank selection process until a preset button is pressed.

**Function** – This button is set up to switch between button pages. Each page of buttons can have different functions. Initially, the first button page is set up to access presets and banks, and the second button page is set up to control function switches and send MIDI CC messages.

Using the Mastermind Editor software, you can redefine any button's functions – these are only the default settings.

## Main Display

The main display shows the current preset or song name as well as status of the Mastermind LT's function switches and IA buttons on page 2. Each indicator changes to white text on a black background to indicate that it's active.

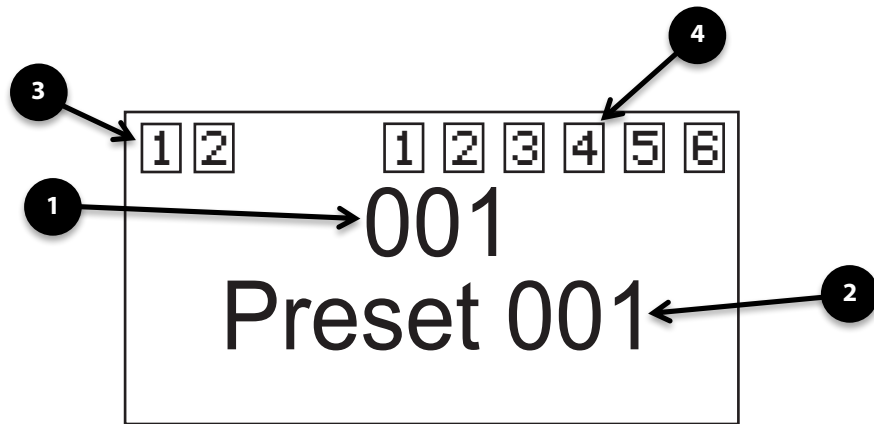

**1. Preset Number** – shows the current preset number. Alternately, displays song name in Song and Setlist mode, or the current button page name if there is one.

**2. Preset Name** – shows the name of the current preset

**3. Function Switch Indicators** – indicates which of the two function switches are currently active

**4. IA Indicators** – indicates which of IA buttons on page 2 are currently active.

## Rear Panel

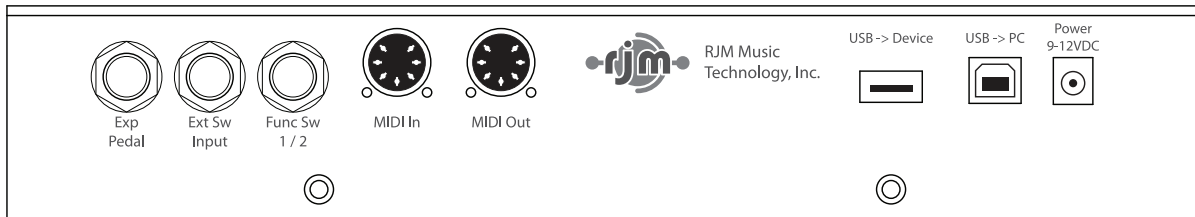

### Rear Panel Connections and Switches

**Exp Pedal** – An expression pedal can be connected to this port using a ¼" TRS cable. This pedal can be used to control parameters on connected MIDI devices. Refer to the Expression Pedal section for more details.

**Ext Sw Input** – An external footswitch can be connected to this port to add two more switches to the system. The port can take a single or double footswitch connected with a ¼" TRS (tip-ring-sleeve) cable. These switches are fully configurable using the Mastermind Editor software and can perform all the operations the on-board switches can. Refer to the External Switch section for more details.

**Func Sw 1/2** – The function switches allow you to control the channel switching and other footswitchable functions on amplifiers. They will work with most amplifiers and other devices that have a ¼-inch switching input.

**USB -> Device** – This is a USB port designed for use with a USB flash drive. A flash drive can be used to back up or transfer settings, and is also used for firmware upgrades.

**USB -> PC** – This USB port is designed to connect to a PC or Mac. When connected, the Mastermind LT will appear as a MIDI interface connected to the computer. The computer will power the Mastermind LT, eliminating the need for a separate power supply.

**MIDI In** – This is a MIDI input port. It can be used for receiving MIDI patch data, program changes or can be used to link multiple Mastermind LTs together into a multi-unit system. You can use a standard 5-pin MIDI cable in this port. If you use a 7-pin MIDI cable, this port will pass phantom power to a connected device.

**MIDI Out** – This is the main MIDI output. Connect this port to the MIDI device(s) you wish to control. You can plug a standard 5-pin MIDI cable in here, or you can use a 7-pin cable to pass phantom power to the Mastermind LT from another device.

**Power** – This is the main power input for the Mastermind LT. The Mastermind LT requires a 9VDC or 12VDC supply at 200mA. You can use a Voodoo Lab Pedal Power 2+ to power the Mastermind LT if you use one of the Line 6 outputs that can supply 250mA. Larger Pedal Power units will also work if you use one of the 400mA outputs.

**NOTE!** Be sure to only connect one power source to the Mastermind LT at a time.

## Basic Operation

### Preset Mode

When you power up the Mastermind LT, you start off in the preset and bank selection mode. The Mastermind LT has 768 presets that you can choose from, and they're arranged in banks of four. Pressing one of the four preset buttons (1 – 4) selects a preset in the current bank. When the LT powers up, it starts in the first bank (presets 1-4). Pressing **Bank Up** shifts up one bank to presets 5-8. When doing bank selection, the main display inverts and scrolls through each preset in the new bank, displaying the name of the preset and illuminating the button that selects that preset. At this point, you can keep pressing the **Bank Up** or **Bank Down** buttons to get to a different bank, or you can press one of the preset buttons to finalize your selection.

The **Function** button switches to other button pages. Each button page can perform different functions. By default, there are two pages defined. The first is the preset and bank page we've just described. Pressing the Function button once will bring you to the next page, which is the IA page:

### IA Page

The second button page is called the Instant Access (IA) page. This page sends MIDI CC (continuous controller) messages to a connected MIDI device. These messages are usually used to turn effects on and off in an audio loop switcher or digital effects processor. By default, the buttons send CC numbers 88-93 to a connected MIDI device on MIDI channel 1. Button 1 sends CC#88, button 2 sends CC#89, etc. Pressing the button once turns it on, pressing it again turns it off.

On this page, the **Bank Up** and **Bank Down** buttons have secondary functions that are activated by holding the button for 2 seconds. Holding **Bank Down** toggles the first function switch on or off, and holding **Bank Up** toggles the second function switch on or off.

The on/off state of these IA buttons and Function Switches will always be indicated at the top of the main display.

These pages and button definitions are defaults, but they can be redefined using the setup mode or the Mastermind Editor software.

### Programming a Preset

You can program each of the Mastermind PBC's presets to automatically send CC messages and/or turn function switches on or off. To do this, follow these steps:

1. First, select the desired preset using the bank and preset buttons
2. Press the **Function** button to switch to the IA page
3. Use the **1** through **6** buttons to select which IA buttons should be turned on for this preset
4. If needed hold the Bank Up and/or Bank Down button to turn the function switches on or off
5. Hold the **Function** button for 3 seconds to store.

When you select a preset, the Mastermind LT will recall the saved IA buttons' states and will send the corresponding MIDI messages. This allows you to have effects switch on and off automatically when you select presets.

You can repeat this programming process for each of the Mastermind LT's 768 presets.

## MIDI & Preset Setup

Each Mastermind LT preset can also send MIDI program changes to up to 16 connected MIDI devices, and perform many other functions.

### Entering Setup Mode

To edit MIDI settings, you first need to enter Setup Mode. Do this by holding the **1** and **3** buttons for 3 seconds. The main display changes to the setup menu, and the buttons operate according to the labels printed on the left side of the buttons:

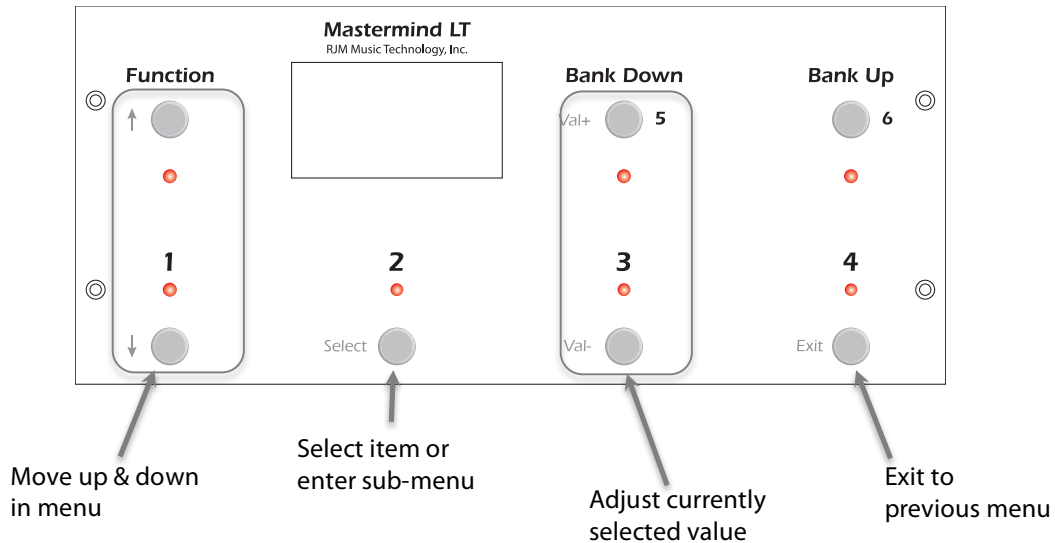

### Adding a Device

The first thing that needs to be done is to add a device entry to the Mastermind LT for each device you wish to control. Once in the setup menu, select the **Edit Devices** option by using the **down arrow** button to highlight the option, and the **Select** button to select the item.

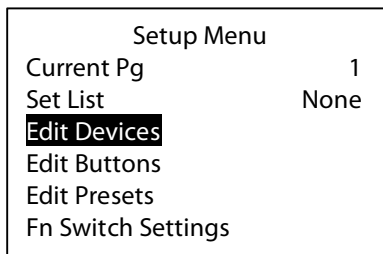

You will see a list of devices defined in your system. By default, a single Mini Effect Gizmo is defined. You can select the Mini Effect Gizmo if you want to replace that device with another, or you can select another empty device slot to add a second device of another kind. Use the **Up and Down Arrow** buttons to move to the desired slot, and press **Select** to select it.

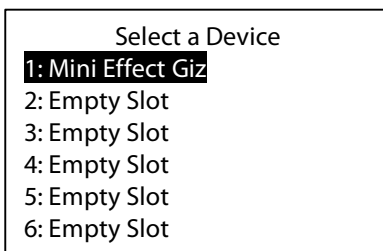

Once a device slot is selected, you are

taken to the Device Edit screen. Select

the **Type** option to set the type of this device.

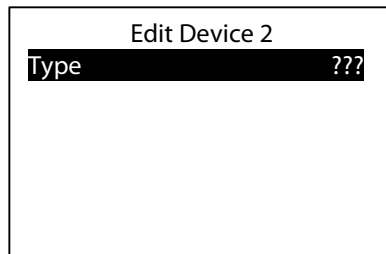

You will be presented with a list of device manufacturers. Select your manufacturer from the list, then select the model of the device in the next list that is presented.

If your device (or device manufacturer) is not listed, you can select **Generic** for the manufacturer and **PC/CC Device** for the device model. This will allow you to control most effect processors and loop switchers. You will need to manually type in the device name and other parameters.

If your device is listed, the Mastermind LT can set up many of the device parameters for you. What it can do varies from device to device. At the minimum, it can set up the device name and the number of presets and banks the device has. Some devices have additional support including the ability to select effect parameters by name when assigning the expression pedal. The Mastermind LT editor software will allow you to access even more special support. The Device Edit screen shows you the options available for your device:

The screenshot shows a rectangular window titled "Edit Device 2". Below the title, there is a list of parameters and their values. The "Type" parameter is highlighted with a black background and white text. The other parameters are in a standard black font on a white background.

Type	Mini Effect Giz
Name	Mini Effect Giz
MIDI Ch	1
Port	MIDI Out
Preset Offst	0
Max PC #	127

One important parameter that needs to be set for every device is the MIDI channel (**MIDI Ch**). The MIDI channel is very important because it insures that each device receives the messages it's supposed to – and doesn't receive the messages that are intended for other devices.

Typically, each MIDI device needs to be set to its own MIDI channel. This number needs to be set here on the Mastermind LT and also on the device itself. (Most MIDI devices have a MIDI Channel or MIDI Receive Channel parameter). To set the channel on the Mastermind LT use the **Up and Down arrow** buttons to move to the **MIDI Ch** parameter and use the **Val +** and **Val –** buttons to adjust the channel number.

You can also change the name of the device if desired. Move to the **Name** parameter, and press **Select**. Follow the instructions in the **Setup Mode Reference** section of the manual.

The other parameters are also described in the **Setup Mode Reference** section of the manual.

Once you're done editing the device, press **Exit** to go back to the device selection menu. You can either add another device here, or press **Exit** two more times to get out of setup mode completely.

### Assigning Program Changes

Once you've defined the devices you're going to control, you can edit each preset to assign which MIDI program change message is sent to each device. This allows you to select presets on effect processors or other devices.

To do this, enter setup mode by holding the **1** and **3** buttons for 3 seconds. After entering Setup Mode, select the **Edit Presets** option:

Setup Menu	
Set List	None
Edit Devices	
Edit Buttons	
<b>Edit Presets</b>	
Fn Switch Settings	
MIDI Settings	

You'll be presented with a list of presets:

Select a Preset	
<b>Global Preset</b>	
1: Preset 1	
2: Preset 2	
3: Preset 3	
4: Preset 4	
5: Preset 5	

Choose the preset you'd like to edit, and you'll be presented with some options:

Edit Preset 1	
Name	Preset 1
Page	1
Tempo	0
Copy Preset	
Mini Effect Giz	0
- None -	

At the end of the list, you will see the devices you set up in the previous section (starting with "Mini Effect Giz" in this example.) Select the device you'd like to edit.

Edit PC Message	
PC	0
Bank	0

You can use the PC and (optionally) Bank options to select the desired preset on the device. If the device is connected, you should see the device change programs as you adjust the values. Pressing the **Bank Up** button in this menu sets the PC and Bank values to **None**, which means that no MIDI messages will be sent to this device for this LT preset.

You can repeat this process for each preset and device within each preset.

## Song and Setlist Mode

For live performances, your Mastermind LT presets can be arranged into **Songs** and **Setlists**. Using this feature allows you to group presets by song and makes it easy to rearrange those songs for each performance.

A **Song** is a group of presets – up to 16 of them – that are selected for use in a particular song. Each preset is typically chosen for the sounds needed in different parts of a song: intro, verse, chorus, bridge, solo, etc. Each preset in a song can be chosen from any of the 768 presets defined in the system, and presets can be used in more than one song.

A **Setlist** is an ordered list that represents the songs you're going to play in a particular performance. You press a button to move to the next song in your setlist as you finish each song.

When Song and Setlist mode is active, the Bank Up and Bank Down buttons move from song to song instead of moving from bank to bank. When a song is selected, the preset buttons on the current button page display the presets assigned to the song. If there are more presets in the song than there are visible preset buttons, the remaining presets will not be displayed.

**Please note!** Even though you can specify up to 16 presets per song, you can only access as many presets as you have preset buttons on your Mastermind LT. By default that means you can use 4 presets per song. If you use the Mastermind LT editor, you can convert more of the buttons to preset buttons if needed, or you can assign Preset - and Preset + buttons, which allow you to step through all of the presets in a song, regardless of the number of preset buttons you have.

### Editing Songs

The first step in setting up for Song and Setlist mode is to edit your songs. Hold the **1** and **3** buttons to enter Setup Mode. Select **Edit Songs** to get to the Song Edit menu. You will first be shown a list of songs that are defined in the system. Select the song you wish to edit from this list.

Select a song from the list. There are over 1000 songs available for you to edit. The default name for each song is "Song x", where x is the song number, but you can change this name to anything you like in the next menu.

Selecting a song brings up the Song Edit menu. From this menu, you can edit the song's name and assign up to 16 presets to the song.

You can also assign a tempo to each song. This tempo is used for each preset in the song unless overridden by a preset. The tempo is transmitted to your devices using MIDI clock or the Auto-tap feature.

Selecting any of the preset slots located below the **Name** item will bring up a menu of all your presets, allowing you to select which preset goes in each slot. When in performance mode, the presets will be assigned to the preset buttons in the order they appear in the song's preset list.

### Editing Setlists

Once all your songs have been created, you can use a setlist to put them in the order you're going to play them in a performance. You can define up to 64 setlists for different performances, and you can have up to 100 songs in a setlist.

In the Setup Menu, select Edit Setlist. You are presented with a list of all 64 setlists. Select one of the lists and the Setlist Edit menu will be displayed.

Just like you add presets to a song, you also add songs to a setlist by selecting one of the song slots, then selecting the song that should go in that slot. As with a song, you can edit the setlist name using the **Name** button.

### Using a Setlist

Once your songs and setlists are defined, you're ready to use one of your setlists in a performance. Enter Setup Mode, then use the Set List option to select which setlist is active.



In the menu that pops up, you can either choose your desired set list, choose "All Songs" which puts all 1008 songs in one large setlist, or choose "None" to select no setlist and return to normal preset and bank mode.

## Editing Button Pages

On the Mastermind LT, you can set up to 16 button pages, each of which can have a completely different button configuration. Each press of the Function button moves to the next available button page. By default, there are two button pages. The first page allows you to select banks and presets, the second page has Instant Access buttons that send MIDI CC messages to a connected device, and also let you control the Mastermind LT's function switches.

To set up new button pages, or edit new pages, you use Setup Mode. Hold the **1** and **3** buttons for 3 seconds to enter Setup Mode. Then, select the **Edit Buttons** option:

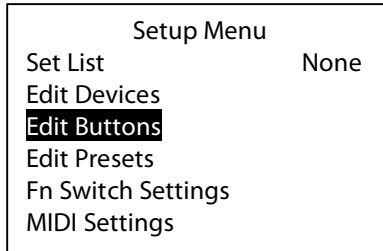

You will be presented with a list of the currently defined button pages:

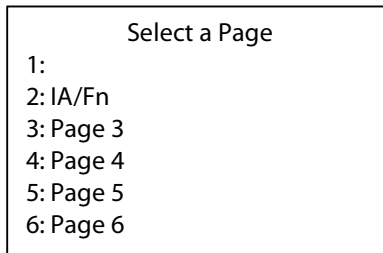

Select the page you wish to edit, and you will then see these options:

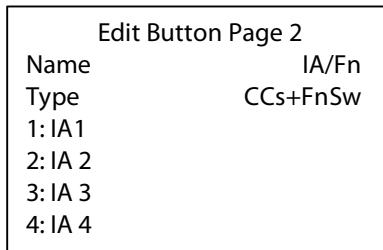

On this page, you can edit the page name. This name will be displayed on the Mastermind LT's main display when the page is active. To make the page name not show up in the main display, make the page name blank. (This is done on page 1 by default).

### Button Page Type

The **Type** option allows you to select what type of button page you're going to use. The possible types are:

**Off** – This button page is disabled

**Preset** – Preset and bank buttons (*default for page 1*)

**CCs+FnSw** – All buttons send CC messages and two buttons also control Function Switches when the switch is held down. (*default for page 2, see below for details*)

**CCs** – All buttons send CC messages

**Device PC** – The buttons allow you to send PC messages connected MIDI devices (see Device PC section below)

**Notes** – All buttons send MIDI note messages

Button pages that have been edited using the Mastermind Editor software will be shown as **Custom**. You can't edit these pages on the Mastermind LT itself, unless you change the page type to something other than **Custom**, which returns the page to a standard configuration.

Selecting a different button type will bring up a requested asking if it's OK to overwrite the current button page's settings. Answering yes will change the button page type and overwrite all button settings on that page.

Once the button page type has been defined, you can edit each button by selecting one of the button entries below the **Type** parameter. Different button page types have different sets of parameters:

### CCs and CC+FnSw Types

"CCs" and "CC+FnSw" button page types send a MIDI Continuous Controller (CC) message when each button is pressed. Each button toggles between on and off, and can send a different CC value for each state.

The "CC+FnSw" button page also allows you to turn the Mastermind LT's function switches on and off. Holding the **5** button toggles Function Switch 1, Holding the **6** button toggles Function Switch 2

On these page types, you can edit the following parameters on each button:

- Name** – Allows you to set the button name
- Device** – Selects which device this button sends its CC message to
- CC Number** – Selects which CC number to send
- Off Value** – Selects the value to send when the button is turned off
- On Value** – Selects the value to send when the button is turned on

Each button page defaults to different CC numbers. Off Value is 0 and the On Value is 127 by default.

Buttons on this page type light up blue when turned on.

Holding the **Function** button for 3 seconds stores the state of each IA button and Function Switch to the currently selected preset. These settings will be recalled the next time the preset is selected.

### Device PC

The "Device PC" button page type sets up buttons that send MIDI Program Change (PC) messages to connected MIDI devices. Pressing a Dev PC – button subtracts 1 from the current PC number, then sends a new PC message. Pressing a Dev PC + button adds 1 to the current PC number and sends a new PC message. This allows you to step through all the presets on a connected MIDI device.

On supported MIDI effect processors, you can also bypass the device by holding down the button for 2 seconds. This sends the appropriate MIDI command to the processor to bypass the device. Pressing a Device PC + or Device PC – when the device is bypassed enables the device again.

You can edit the following parameters on a Device PC page button:

- Name** – Allows you to set the button name
- Device** – Selects which device this button sends its PC message to
- Type** – Selects whether this button decrements the PC number (PC-) or increments it (PC+)
- Bypass Dev** – Selects which device is used when sending a bypass MIDI message. This can be the same device as the Device setting above, but can also be a different device, which is the case when using a true bypass loop switcher to bypass a pedal. Set this to "-None-" to disable the bypass feature.
- Bypass CC** – The CC number that should be sent to the bypass device.
- CC Act Value** – The CC value to send when the device is supposed to be active
- CC Byp Value** – The CC value to send when the device is supposed to be bypassed

By default, buttons 1 and 2 control Device 1 and are colored blue. Buttons 3 and 4 control Device 2 and are colored green. Bank Up and Bank Down control Device 3 and are colored purple. Holding a button for 2 seconds bypasses the

device and turns the device's buttons red. Holding it again activates the device and returns the buttons to their normal color. The buttons are set to send CC#102 by default, which is the CC used to bypass Strymon pedals. This can easily be changed to control pedals from other manufacturers.

Holding the **Function** button for 3 seconds stores the PC number and bypass state of each device to the currently selected preset. These settings will be recalled the next time the preset is selected.

### Notes

The "Notes" button page type allows the Mastermind LT to send Note On messages to a connected device. Pressing the button sends a Note On message and releasing it sends a Note On message with velocity 0, which indicates that the note should be turned off. Each button can be set to a different note number.

You can edit the following parameters on a Notes page button:

**Name** – Allows you to set the button name

**Device** – Selects which device this button sends its Note message to

**Note** – Selects which note is sent when pressed

**Velocity** – Selects the velocity of the note

Note buttons light up yellow when held. The on/off state of Note buttons are not stored in presets.

### Preset

The "Preset" button page type is the standard bank and preset page. Buttons 1-4 select presets within the current bank and the Bank Down and Bank Up buttons select the current bank.

## Expression Pedal

The Mastermind LT has an expression pedal port that allows you to connect an external expression pedal. An expression pedal can be used with MIDI-capable effects processors to provide real time control of different parameters: volume level, echo rate, etc. The Mastermind LT translates the position of the pedal to MIDI Continuous Controller messages and sends them out the MIDI Out port. The effects processor receives these messages and alters the effects accordingly.

Using Setup Mode, you can set each expression pedal to set the controller number, minimum and maximum values and which device should receive the controller messages. By default, the pedal sends CC#7 to the first MIDI device.

Many expression pedals on the market will work. Pedals that have a stereo (TRS) 1/4" output jack and have the potentiometer wiper connected to the ring conductor of the output jack will definitely work. The Rocktron Hex and Korg XVP-10 are examples of pedals that work well, and the Boss FV-500 and Roland EV-5 are examples of pedals that don't work well.

**Note!** Even if an expression pedal does not have the correct polarity, you can still fix it with a specially made cable. Connecting it to the Mastermind LT with a 1/4-inch TRS cable that swaps the tip and ring conductors will allow you to use any Roland/Boss type pedal.

You can also use a standard volume pedal as an expression pedal. For this you need a 1/4" Y-cable, also known as an insert cable. The stereo end of the Y cable plugs into the Mastermind LT and the two mono ends plug into the input and output of the volume pedal:

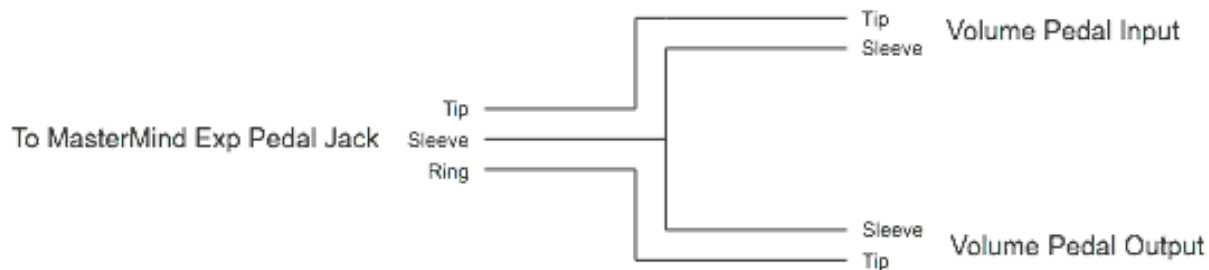

This has the disadvantage that most of the value change will happen at one end of the pedal due to the volume pedal's audio taper. Pedals made specifically to be expression pedals will not have this problem.

### The Mission Engineering SP1-RJM

Mission Engineering makes a model of its SP1 expression pedal that's designed specifically to work with the Mastermind LT. This pedal has a built in toe switch and LED which works as an external switch. The toe switch can perform any function that one of the Mastermind LT's built-in buttons can, using the Mastermind Editor.

To connect the SP1-RJM to the Mastermind LT, you will need two 1/4-inch TRS cables. The first one connects from the pedal's Output 1 jack to the Expression Pedal input on the Mastermind LT. The second cable connects from the pedal's Output 2 jack to the External Switch input on the Mastermind LT.

### Expression Pedal Setup

You can set up your expression pedal by selecting the **Exp Pedal** option from the main Setup Menu.

The first time you connect a particular expression pedal to the Mastermind LT, you will first want to calibrate it. Expression pedals vary from model to model, and calibrating the pedal insures that the Mastermind LT will always be able to send the correct values for the pedal's position. Simply press the **Calibrate** button, then move the pedal all the way up and all the way down. Press the **Done** button once this is complete.

Basic setup of the expression pedal works like this:

- 1). Use the **Device** button to select the device you wish to control with the expression pedal.
- 2). If the option is available for your device, press the **Assign Pedal CC** button. You will be presented with a list of parameters that can be controlled by the expression pedal. Select one of these functions, and the rest of the parameters will be set for you.
- 3). If the **Assign Pedal CC** option is not available, you can manually set the CC number and minimum/maximum values for the pedal. You can find these numbers in your effect device's manual.
- 4). Some devices, such as the Eventide pedals and the TC Electronic G-Major, support a "learning" function. This means the effect device configures itself based on the messages it's receiving from the Mastermind LT. If you have one of these effect processors, turn on the learning function and move the expression pedal you wish to have control the parameter. The device will automatically adapt itself to the CC number being sent by the Mastermind LT.

The second set of parameters (all labeled with a number **2**) can be used to send a second set of CC messages. This allows you to control multiple devices at the same time and/or cross-fade between two sounds. If the **Device 2** parameter is set to **None**, then the second CC is not sent by this pedal.

### Setting Up The Expression Pedal Position Switch

Each expression pedal can be set to turn a parameter on and off based on the position of the pedal. This is especially useful for turning an effect off when the pedal is raised all the way.

Currently, this function is only programmable using the Mastermind LT editor software. You will, however, need to use the Mastermind LT to choose at what point in the pedal's travel the switch happens. Move the pedal to that spot (typically not quite all the way down or not quite all the way up), then press **Set Switch Position**. The pedal position will be remembered and the selected function will switch on and off as you move the pedal up and down. At this point, read the settings into the Mastermind Editor so that the switch position is saved in your settings. You can now edit the actions that happen when the pedal moves past the saved switch position.

When the pedal goes below the saved switch position, the switch is considered to be on, when the pedal moves up above the switch position, the switch is considered to be off. There is an **Invert Switch** setting that reverses this. If you want the switch to be on when the pedal moves up above the switch position, turn the **Invert Switch** setting on.

## External Switches

The Mastermind LT supports up to two external switches. These can be used to add switches to remote locations, to add different types of switches for specialized functions like tap tempo, or simply to increase the number of available switches.

There is an external switch jack on the rear of the Mastermind LT labeled "Ext Switch". This jack can take a single switch or a double switch with a TRS (tip-ring-sleeve) plug. A single switch should use a TRS plug with the switch connected to the tip and ground, and the ring conductor unconnected to anything. If an LED is wired in parallel with the switch with the cathode connected to the shield of the TRS connector, the Mastermind LT will light the LED when the switch is on.

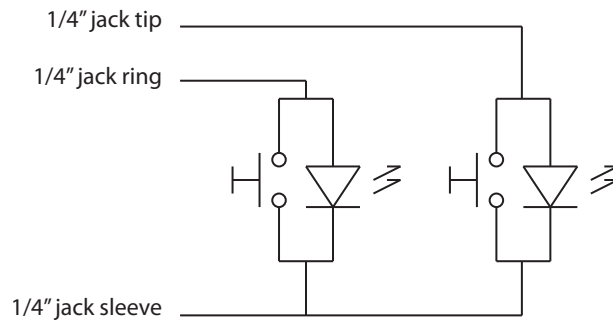

**Mastermind PBC External Switch Wiring Diagram**

*(Note: if you're building your own external switch, please note that the switch must be momentary and normally open, and the LED should be a type with a low forward voltage. Typically, this means red, yellow or green LEDs. Blue or white LEDs will not work.)*

RJM Music sells single and dual external switches made to work correctly with the Mastermind LT, and Mission Engineering's SP1-RJM expression pedal includes a toe switch (similar to the on/off switch on a wah pedal) with an LED that can work as an external switch for the Mastermind LT.

**Please note:** To edit the functions of the external switches, you will need to use the Mastermind Editor software.

## Remote Mode

In Remote Mode, one Mastermind LT can act as a remote control for another. Simply connect the Remote In port of your Mastermind LT to the MIDI Out of the unit that should act as a remote control. If needed, you can even chain more LTs in this way, connecting the Remote In of one unit to the MIDI Out of the next.

When connecting LTs in this way, make sure you use MIDI cables that are “5-pin active”. That is, cables that have all five pins wired through. Not all MIDI cables are wired this way, so it’s best to check.

Make sure both LTs have the **Remote** setting turned on. This setting can be found in the **MIDI Settings** page. Also, make sure that both LTs have the same exact settings. You can transfer settings using a USB flash drive or a computer.

Once the setup is completed, pressing a button on one LT will result in the other LT(s) doing the same action. The LTs will remain in sync with each other.

When the Mastermind LTs are turned on, you’ll notice one or two arrows in the right side of the main display on each unit. The first unit in the chain will have an arrow pointing to the right, the last unit in the chain will have an arrow pointing left and any units in the middle of the chain will have arrows pointing left and right. These arrows indicate that remote mode communication is active.



## External MIDI Control

The Mastermind LT can also be controlled by an external MIDI device such as a computer, sequencer or other type of MIDI controller. To enable this feature, set the **MIDI Rx Ch** parameter in the MIDI Settings menu to the desired MIDI channel. Any bank or Program Change messages received through the **Remote In** or **USB -> PC** ports on this channel will cause a preset change on the Mastermind LT.

The bank and program numbers are interpreted differently based on some settings:

### Setlist=None

In normal bank and preset mode (no setlist active), the bank MSB, LSB and program numbers are combined to create the desired preset number. The formula is:

$$(\text{Bank MSB} \times 16384) + (\text{Bank LSB} \times 128) + \text{PC number} = \text{preset number}$$

There are 768 presets within the Mastermind LT, so only bank numbers 0 through 5 are valid. The Bank MSB should always be set to 0 (or not sent at all), and Bank LSB should be 0, 1 or 2.

### Setlist active, Bank=Song On

If you are using a setlist, and the **Bank=Song** parameter (found in the MIDI Settings Menu) is turned **on**, the Bank MSB and Bank LSB are combined to select a song out of the current setlist. (0 = first song in setlist, 1 = second song in setlist, etc.) The number is calculated as follows:

$$(\text{Bank MSB} \times 128) + \text{Bank LSB} = \text{song number}$$

The PC number selects which preset within the song is selected (0 = first preset in song, 1 = second preset in song, etc.)

### Setlist active, Bank=Song Off

If you are using a setlist, and the **Bank=Song** parameter (found in the MIDI Settings Menu) is turned **off**, the bank MSB, LSB and program numbers are combined to create the desired preset number. The formula used is the same as in the **Setlist=None** section above.

Upon receiving bank and program change messages, the Mastermind LT will find the first song that contains the resulting preset and will load that song and preset.

### Switch Control using CC Messages

When the **MIDI Rx Ch** parameter is set, you can also send Continuous Controller (CC) messages to the Mastermind LT to remotely control the function switches and also to select the currently visible button page. The default CC numbers are as follows:

Function	CC Number	Values
Function Switch 1 off/on	65	0-63 off, 64-127 on
Function Switch 2 off/on	66	0-63 off, 64-127 on
Page Select	75	0-15 (page number-1)

These CC numbers can be customized using the setup menu. Please refer to the Setup Mode Reference section for more details.



## Other Special Features

### Function Switching a.k.a. Controlling Your Amp

The Mastermind LT has the ability to control footswitchable features on many amps. This could be channel switching, reverb, tremolo, etc. – anything that is controlled by a 1/4-inch footswitch jack. The **Func Sw 1/2** and **Func Sw 3/4** jacks are used for function switching purposes. You can use a standard mono 1/4-inch cable, a TRS 1/4-inch cable or an insert cable to connect to these jacks:

**Mono 1/4-inch cable** – this allows you to control one function on an amp with each switching jack. This connection will let you use the first switch from the function switching jack. This connection is typically used with amps that have single button footswitches.

**TRS 1/4-inch cable** – this allows you to control two functions on an amp with each switching jack, providing access to all four function switches. This connection is typically used with amps that have two button footswitches.

**Insert cable** – an insert cable is a 1/4-inch cable that has a TRS (aka stereo) connector on one side and two 1/4-inch mono connectors on the other end. Insert cables allow you to access both function switches on a jack, but split them to two different switching jacks on the amp. This connection is typically used with amps that have a non-standard footswitch jack and more than one 1/4-inch external switching jacks. (Mesa Boogies are good examples of this). **Please note!** Don't connect the two mono plugs of an insert cable to two different amps or other devices – this can cause a ground loop or worse electrical problems.

The default settings for each switch are latching and normal (non-inverted). These settings will work with the majority of amps. If your amp has different requirements, you can use the Fn Switch Settings section of the setup menu to change the settings for each switch.

These Function Switch jacks can also be used to control tap tempo on pedals that have an analog tap input jack. Please refer to the Auto Tap section below for details.

### Global Preset

The global preset is an additional preset that can be accessed from any other preset simply by pressing the currently selected preset button again. This is typically used to set up a preset that is your “standard” or “go-to” guitar sound that’s always accessible, no matter what bank of presets you’re currently using.

There are several ways to access the global preset. You can set up the preset buttons so that a 2<sup>nd</sup> press on a preset button calls up the global preset. To do this, enter Setup Mode and set the **Preset 2nd** (Preset 2<sup>nd</sup> Press) option to “Global”. Setting it to any other setting disables the global preset feature.

Using the Mastermind Editor, you can also set any IA button to access the global preset using a System / Preset action (see the Mastermind Editor manual for details).

### Tap Tempo and MIDI Clock

The Mastermind LT supports MIDI clock as a master or slave. With MIDI clock, you can synchronize multiple devices to the same tempo. To enable MIDI clock support, go to the **MIDI Settings** menu. The **MIDI Clock** parameter can be set to “None” (the default), “Master” or “Slave”.

When set to “Master”, the Mastermind LT will send a MIDI clock signal out of all MIDI outputs, including the USB port. The tempo will be adjusted any time a tap tempo button is used. Tempo can also be set on a per-song and per-preset basis. Each song and preset has a **Tempo** parameter. Setting it to a non-zero value will cause the tempo to be set to the new BPM value when the preset is selected. A preset’s tempo value will override any tempo set by a song. In Song and Setlist mode, you can set a preset’s tempo to 0 to use the song’s tempo instead. If both the preset’s tempo and the song’s tempo are set to 0, no MIDI clock output will be generated until a preset or song is selected that has a non-zero tempo defined.

Using the Mastermind Editor software, you can assign a button or external switch to act as a tap tempo button and have the button's LED flash with the tempo.

When set to "Slave", the Mastermind LT will flash any tempo buttons in time with the incoming MIDI clock signal. It will also forward the MIDI clock signal to its other MIDI outputs. This allows the Mastermind LT to receive a MIDI clock signal from a computer via USB and forward it over standard MIDI connections to your other MIDI devices.

### Auto Tap

The Mastermind LT also has support for devices that only have an analog tap tempo input, or accept tap tempo over MIDI, but not using MIDI clock. The LT can automatically send taps to the device when you select each preset, adjusting the tempo on the device. To enable this feature, you need to set up a Macro. This is described in the Mastermind LT Editor Manual. The Macro contains instructions telling the LT what to do – it can activate a Function Switch output (in the case of analog tap tempo), or can send the appropriate MIDI commands to a device or devices.

Once the Macro has been defined in the editor, you set the **Auto Taps** parameter in the main setup menu. Set it to the number of taps the device should receive (setting it to 0 disables the feature). Then, set the **Tap Macro** number to the number of the macro you wish to use. Once these parameters have been set, the Mastermind will execute the macro the specified number of times at the requested tempo. This will happen every time the tempo changes due to a song or preset change.

## Loading and Saving Settings to a USB Flash Drive

The Mastermind LT allows you to load and save settings to a USB flash drive. You can use this feature to back up settings, transfer settings from one Mastermind LT to another LT, or to transfer settings to or from a computer.

The drive is plugged into the **USB -> Device** port on the rear panel. Loading and saving are done from the System Menu. To get there, hold the **1** and **3** buttons. When the setup menu appears, select **System Functions**.

At the top of the menu, you will see the **Load Settings** and **Save Settings** options.

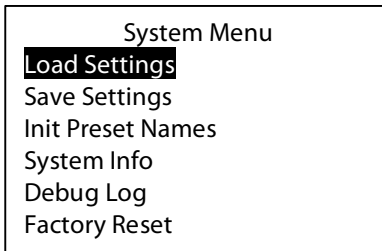

### Load Settings

When **Load Settings** is selected, you are shown a list of the files that are on your flash drive. Only RJM settings files (ending in .rjs) and directories are visible. The **Up Arrow** and **Down Arrow** buttons move the selection bar up and down.

Selecting a directory with the **Select** button views the contents of that directory, and selecting a file loads the settings in that file. You can press the **Exit** button at any time to cancel out of the load process and leave your settings unchanged.

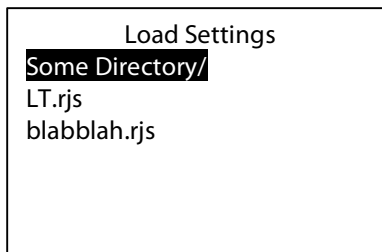

If the file loads without errors, your Mastermind LT will now be running with the new settings from the file.

### Save Settings

Selecting **Save Settings** will bring up a menu that allows you to edit the filename you wish to give the settings. Edit the filename, then press **Select**. Please refer to the Setup Mode Reference section for information on how text is edited on the Mastermind LT. If a file of that same name exists, you will be asked if it's okay to overwrite the file. If you answer Yes (or if there is no pre-existing file to overwrite), the settings file will be saved to the top level directory of the flash drive.

Please note that all settings files need to end with ".rjs". You don't need to type this in, however. The system will add the extension for you if you don't type it in yourself.

## Connecting to a Computer

In addition to the USB flash drive support, the Mastermind LT's **USB -> PC** port allows you to connect your controller to a PC or Mac with a USB port. The Mastermind LT is a class-compliant USB MIDI device, which means it doesn't need additional driver software. The Mastermind LT will appear as another MIDI device in your system, and will work with any MIDI-enabled programs you're using.

To get the Mastermind LT to send commands over the USB port, use the Edit Devices menu to set the **MIDI Port** parameter of one device to "USB". Any messages that are sent to that device will be sent over the USB port instead of the standard MIDI ports. Since you're communicating with a computer instead of an effect processor, you will most likely want to create a Generic MIDI device and set its **MIDI Port** parameter to "USB". That will allow you to send commands to a computer without affecting the settings you have for your other MIDI devices.

The Mastermind LT has been tested successfully on PC systems running Windows 7 through Windows 10. Windows XP systems are not supported. Mac OS 10.8 through 10.12 systems are also known to be compatible with the Mastermind LT. Older Mac OS versions will likely work, but are not tested at this time.

### Mastermind Editor

The Mastermind Editor software is available for free on our website. This software makes it even easier to edit your LT's parameters and back up settings to your computer. It also allows you to do more extensive customization of your LT's button pages and MIDI configuration. Settings can be transferred from the LT to the computer and vice versa using a USB flash drive or a direct USB connection from LT to computer.

## Updating Firmware

The Mastermind LT is designed to be easily updated by the user. Firmware updates will be periodically made available on the RJM Music website. These updates will add support for more devices and add other new features.

The firmware update process is simple: first, download the firmware file from the RJM Music website using your PC or Mac. Copy the downloaded file to a USB flash drive. All RJM firmware files end in the extension “.rjf”, so it will be easy to tell which files are the ones you want.

Once the file is loaded to the flash drive, use the “Eject” option on the computer to safely remove the drive. On the Mac, this is done by pressing the eject arrow next to the drive’s name in the left column of the Finder. On the PC, go to “Computer” or “My Computer”, right click on the flash drive’s icon and select “Eject”. You can now remove the flash drive from the computer.

At this point, there are two ways to start the firmware update:

1). Enter Setup Mode, select **System Functions**, then select **Update Firmware**. Plug your flash drive into the Mastermind LT. A list of firmware update files will be shown. Select the desired firmware file, and the update process will begin.

-OR-

2). If there are any other .rjf files on the flash drive, delete them now. Using this method, the Mastermind LT will load the first .rjf file it finds, so keeping only one firmware file on the drive at a time will make sure that the correct firmware is loaded. Start with the Mastermind LT powered down. Hold the **1** and **3** buttons, and while still holding them, power up the Mastermind LT. Once you see text on the screen, you can release the buttons. Now plug the flash drive into the LT. The upgrade process will take a minute or two, then the Mastermind LT will start up. Once it’s in the normal operating mode (all the displays lit up and a song or preset name displayed), you can unplug the flash drive and begin using your updated LT.

## Setup Mode Reference

Setup mode allows you to perform basic configuration of the Mastermind LT. This on-board editing is designed to allow configuration of the most common functionality and features. Complete editing is available using the Mastermind Editor software available for Mac and PC.

To enter setup mode, press and hold the **1** and **3**. After about 3 seconds, the display will change, indicating you're in setup mode.

In Setup Mode, the footswitch buttons switch from their normal functions to become a menu for selecting setup options. The text labels to the left of the buttons indicate their function when in Setup Mode.

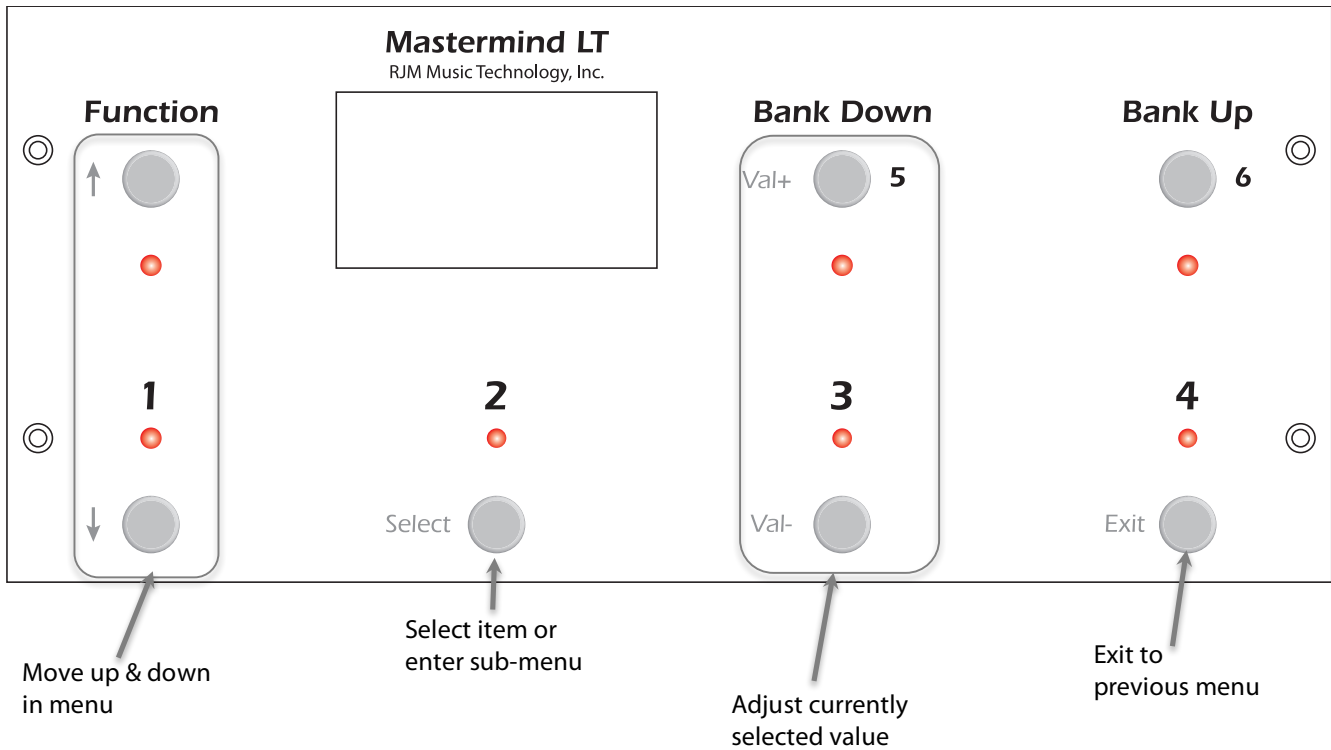

### Text Entry

When editing names and other text, the Mastermind LT uses a special button configuration:

Text is edited by moving the cursor back and forth using the **Up Arrow** and **Down Arrow** buttons, then using the **Val +** and **Val -** buttons to change the value of the character under the cursor.

The **Bank Down** button deletes the character to the left of the cursor.

The **Bank Up** button inserts a space character at the current cursor location.

The **Mute** button deletes all text.

Press **Exit** when you've finished editing the text. The text will be saved and you'll be returned to the previous menu.



## Main Menu

The first menu you see upon entering Setup Mode allows you to configure some system options as well as access submenus to edit devices, buttons and presets.

**Set List** – Pressing this button allows you to select which setlist is active, and enables Song and Setlist Mode. When set to “All Songs”, all 1008 songs will be used as your setlist. When set to “None”, the controller displays your presets normally: by preset number and bank.

**Edit Devices** – Brings up the Edit Devices menu.

**Edit Presets** – Brings up the Edit Presets menu.

**Edit Buttons** – Brings up the Edit Buttons menu. Refer to the Editing Button Pages section for complete details.

**Fn Switch Settings** – Brings you to the Function Switch Settings menu.

**MIDI Settings** – Brings you to the MIDI Settings menu.

**System Functions** – Brings you to the System Functions menu.

**Edit Songs** – Brings up the Edit Songs menu. This menu is described in the Song and Setlist Mode section.

**Edit Setlists** – Brings up the Edit Setlists menu. This menu is described in the Song and Setlist Mode section.

**Exp Pedal** – Brings up the Expression Pedal menu.

**Copy Button** – This button allows you to copy one button to another location. You will first be asked to select which button you wish to copy, then where you wish to put the button. The new button will be an exact copy of the first button, performing exactly the same functions.

**Swap Buttons** – This button allows you to swap the position of one button with another. You will be asked to select two buttons. After the second button is selected, the two buttons’ positions will be swapped.

**Function Button** – Allows you to select what the **Function** button does in preset mode. By default, this is set to access the global preset, but you can also program it to be a tap tempo button or to control a connected Mini Effect Gizmo.

**Current Pg.** – Sets the currently visible button page. This is useful if you accidentally find yourself on a page that doesn’t have a Page Select button defined.

**Max Page** – Sets the maximum page button page that will be visible. There can be up to 16 button pages, but it’s best to limit the number of pages to those you actually need so that finding your page will be easier. When using a local preset button page, this page will always be visible, regardless of the Max Page setting.

**Preset 2nd** – Selects which action is taken when a preset button is pressed a second or subsequent time. Possible settings are:

- *Same* (default) – stays on the same preset.
- *Previous* – causes the LT to switch back to the previously selected preset upon the second press of a preset button.
- *Global* – causes the LT to switch to the global preset. (See the Global Preset section for details).
- *Reload* – stays on the same preset, but reloads the preset, resetting IA states and device PC numbers back to what was stored in the preset.
- *IA* – toggles the button’s IA state. The actions in the button’s action list are run, sending MIDI messages or performing other system functions. When the button’s IA state is on, the button’s IA On Color is displayed unless the IA On Color is set to black.

**Start Last Prst** – When this is turned on, the Mastemind LT will start up on the last preset you selected before turning the LT off. When this is turned off, the Mastermind LT will always start up on preset 1.

**1st Prst is 0** – Determines the number of the first preset in the system, either 1 (the default) or 0. This can be used to adjust the Mastermind LT's numbering scheme to match your effects processor. Please note that this parameter only changes the preset numbers, not the name, so the default names (Preset 001, Preset 002, ...) will not change. You can use the **Init Prst Names** option in the System Functions Menu to reset the preset names using the current preset offset.

**Hold mSec** – Sets the number of milliseconds needed to activate a button's secondary hold function. The default value is 1200 msec (1.2 seconds)

**1<sup>st</sup> Rpt mSec** – Sets the number of milliseconds needed before a button repeats the first time. This is used on buttons like Bank Up and Bank Down that repeat if you hold them down. The default value is 1500 msec (1.5 seconds).

**Repeat mSec** – Sets the number of milliseconds needed before a button repeats the second and subsequent times. The default value is 300 msec (0.3 seconds).

**Bank Scroll mSec** – When you enter bank selection by pressing a bank up or bank down button, the Mastermind LT will scroll through all of the presets in the currently selected bank, displaying the preset's name and lighting up the button that selects the preset. The parameter sets the number of milliseconds that each preset name is displayed before switching to the next preset.

**Auto Page** – When this setting is turned on, selecting a new preset will cause the button page to change to the page number stored within the preset. When turned off (the default), the current button page will not change unless you press a Page button or execute a Page action.

**Instant Bank** – Instant Bank mode, when turned on, will automatically switch presets when you press the Bank Up or Bank Down buttons. Instead of flashing the preset buttons, asking you to select a preset in the new bank, the LT will switch banks and load the preset that appears on the currently selected preset button. For example, if you are on preset 3, and there are 5 presets per bank, pressing bank up will automatically switch to preset 8.

**Auto Taps** – Indicates how many times the Tap Macro should be run when the system tempo changes. Set this to 0 to disable Auto Tap. See the Other Special Features section for more details.

**Tap Macro** – Which Macro should be run for each Auto Tap. See the Other Special Features section for more details.

**Show Button Name** – When selected, the name of each button you press will be displayed briefly on the screen. Certain buttons such as preset and bank buttons already affect the main display, and because of that, their names are not displayed.

**Show Exp Pedal Pos** – When selected, the current expression pedal position is shown as a bar graph on the right side of the main display.

**Show Tempo** – When selected, the tempo is shown briefly in the main display when the tempo changes. Small tempo changes (< 1bpm) are not shown.

**Contrast** – Adjusts the main display contrast.

## Edit Devices

The Edit Devices menu allows you to define which devices are connected to the Mastermind LT. The Mastermind LT contains a database of information about popular MIDI devices and can do a lot of the setup for you once you tell it what kind of devices are connected.

The first thing that is presented is a list of the available device slots. Each slot will either show a device name or "None". You can select any of these slots, which will take you to the device edit screen for that slot.

Once you have selected the device you wish to edit, you are taken to the Edit Device Menu.

### Edit Device Menu

**Type** – Sets the type of device that is in this slot. The menu first prompts you for the device manufacturer, then the device model. If your device is not listed here, you can use the Generic setting, which will allow you to manually configure parameters.

**Name** – Allows you to edit the name shown for this device.

**MIDI Ch** – Sets the MIDI channel for this device. This number needs to be the same as the channel that is set on the device itself. Most MIDI devices have a setting titled “MIDI Channel” or “MIDI Receive Channel”, and this is the parameter you need to change to match the setting here.

**Set Default Pedals** – Sets the expression pedal to control the a commonly used function on the device.

**Get Preset Names** – Brings up a dialog that allows you to select which presets’ names to download to the Mastermind. This function is only supported on a few devices like the Axe-Fx and Kemper Profiling Amp.

**Auto Names** – Only available on the Kemper Profiling Amp. Allows the LT to work with the KPA’s Performance Mode, displaying preset and rig names in real time. This option does not change the stored preset or song names in the Mastermind LT, it only displays the information from the KPA.

**Sync Names** –As presets are selected on the Mastermind LT, the stored preset name is replaced by the name of the current preset in the connected MIDI device. This allows preset names to always be in sync. This function is only supported on a few devices like the Axe-Fx and Kemper Profiling Amp.

**Direct Send** – When turned off, PC and CC messages will be sorted by number and duplicate messages will be deleted. This reduces the amount of MIDI traffic, but may cause problems if you need your messages to be sent in a certain order. Turning Direct Send on will turn off this sorting and duplicate checking. Messages will be sent in the order shown in each action list.

**Port** – Press to select the MIDI port this device is connected to – either MIDI Out, Remote In or USB. Normal connections will use the “MIDI Out” selection. Use “USB” to communicate with a connected computer.

**Preset Offset** - Sets the starting preset number for a device. Effect processors typically start numbering their presets with number 0 or 1. Setting this number correctly will insure that the preset numbers on the Mastermind LT agree with those on the effect processor.

**Max PC #** - Sets the maximum program change number accepted by a device. MIDI specifies a maximum number of 127, but not all effect processors have that many presets. Setting this correctly insures that the Mastermind LT doesn’t send a program change number that’s too large. On devices that support MIDI banks, this determines how many presets are in each bank. This is typically set to 127, but some devices use a smaller bank size.

**# of Presets** - Sets the total number of presets the device has.

**Bank Type** – Sets the type of MIDI bank message accepted by a device. MIDI bank messages are used to access more than 128 presets on a device. There are several ways this can be done, and the type of banks used will vary from device to device. The possible settings are: None (no bank support), LSB, MSB and MSB:LSB.

**Flat Numbering** – This setting controls how you specify presets and banks to devices that support MIDI banks. When checked, you can specify preset numbers for this device as a single preset number. When not checked, you select presets using a PC number and bank number.

**Init PCs -None-** – Initializes all presets for this device. Selecting this option will initialize all presets on the Mastermind LT to send no program change messages to this device. This is different than turning the **Send PC** setting off in that it

can be overridden on any preset using the Edit Presets menu and assigning a PC number to this device for one or more presets.

**Init PCs All 0** – Initializes all presets for this device. Selecting this option will initialize all presets on the Mastermind LT to send program change number 0 to this device.

**Init PCs Sequential** – Initializes all presets for this device. Selecting this option will initialize all presets on the Mastermind LT to send a sequential program change number to the device. Preset #0 will send program change #0, preset #1 will send program change #1, etc. This is the default setting for a new device.

**CC On Preset** (Send CC on Preset Change) – When set to “On”, this device will receive CC messages every time the preset changes, and when an IA button is pressed. When set to “Off”, this device will only receive its CC messages when an IA button is pressed.

**Send PC** – When set to “On”, the Mastermind LT will be allowed to send PC messages to the device. When set to “Off”, PC messages will not be allowed. Setting this to “Off” will disable some of the PC and Bank related items in the Edit Device menu.

**SndRdunPC** (Send Redundant PC) – When set to “Off”, the same PC message will never be sent to a device more than once in a row. Some effects processors will cause a gap or hiccup in the audio when receiving a PC message, so turning this parameter off will help prevent that from happening. Turning this parameter to “On” will cause the Mastermind LT to send a PC message when requested, whether it’s a duplicate or not.

**IgnorePCIn** (Ignore Incoming PC) – When set to “On”, any incoming program changes generated by this device will be ignored. Otherwise, these incoming PC messages will cause the LT to change presets when received.

**IgnoreCCIn** (Ignore Incoming CC) – When set to “On”, any incoming continuous controller messages generated by this device will be ignored. Otherwise, these incoming CC messages (and other status messages) will cause the LT to change IA button states.

**Delete Device** – Deletes this device from the system, leaving an empty slot.

### Edit Presets

The Edit Presets menu lets you define which program change messages are sent to each device for the preset, as well as the preset name, expression pedal settings and the current button page.

**Name** – Sets the name of this preset.

**Page** – Sets the number of the button page that will be displayed when this preset is selected. Setting the page to “Same” will keep the current button page when the preset is selected.

**Tempo** – Sets the tempo (in BPM) for this preset. A tempo setting of **0** (zero) indicates that this preset has no tempo defined. See the Tap Tempo and MIDI Clock section for details.

**Exp Pedal** – Brings you to the Expression Pedal menu to allow you to override the global expression pedal settings for this preset.

**Copy Preset** – Allows you to copy the current preset to a new location.

The remaining items show any devices that are defined, and the bank and preset number that will be sent to those devices when the preset is selected. Pressing one of these buttons allows you to change the bank and PC number for the associated device.

### Fn Switch Settings

The Function Switch Settings menu allows you to control the behavior of the function switches. Each switch can be assigned to be latching or momentary, normal or inverted.

**FN1 Invert – FN2 Invert** – When this parameter is set to “On”, the function switch is inverted (shorted to ground when “off”, and open when “on”). When set to “Off”, the function is normal (open when “off”, and shorted to ground when “on”).

**FN1 Momentary – FN2 Momentary** - When this parameter is set to “On”, the function switch is set to momentary. When the switch’s state changes, the relay will turn on for a short period of time, then turn off. When set to “Off”, the function switch is latching – when switching state, it turns on or off and stays that way until the state changes again.

**FN1 On Only – FN2 On Only** – This parameter is designed to be used in conjunction with the **Momentary** setting. When this setting is turned on, the function switch output will only pulse when the switch is turned on, not when the switch is turned off. This setting is used when controlling channel switching on certain amps, but should be left turned off in most cases.

**Momentary mSec** – Controls how long momentary function switches will remain on. The default is 100mSec.

### MIDI Settings

**MIDI Rx Ch** – Sets the MIDI channel that the Mastermind LT will listen to. Any program and/or bank changes received on this channel will cause the Mastermind LT to jump to the selected preset and send all of the MIDI messages corresponding to that preset. This parameter defaults to “None”, which means that the Mastermind LT will not respond to incoming bank or program change messages. Please refer to the External MIDI Control section for more details.

**Bank=Song** – This setting affects what MIDI Bank and Program Change messages do in Song and Setlist mode. Please refer to the External MIDI Control section for more details.

**MIDI Bidir** – Turns bidirectional MIDI support on or off. Certain devices support bidirectional communication between the device and MIDI controller. This allows you to have two way communication with a single 5 pin MIDI cable. Don’t turn this parameter on unless you know your device does support bidirectional MIDI. Bidirectional MIDI only works with the first device in your MIDI chain.

**Remote** – Turning this on enables remote mode. This allows more than one Mastermind LT to be connected together and have them all synchronized together. Refer to the Remote and Expander Mode section for more information.

**MIDI Merge** – When set to “On”, all MIDI messages that are received through the **Remote In** or **USB -> PC** ports are retransmitted through the **MIDI Out** port.

**MIDI Clock** – Determines whether the Mastermind LT acts as a MIDI clock “Master” or “Slave”. Setting this parameter to “None” (the default) disables MIDI clock support. See the Tap Tempo and MIDI Clock section for more details.

The remaining options allow you to set the Continuous Controller (CC) numbers that control individual functions like function switches and page number. Please refer to the External MIDI Control section for more details.

### System Functions Menu

The System Functions Menu allows you to configure low level parameters and do system maintenance.

**Load Settings** – Allows you to select a settings file from the currently attached USB flash drive and load it into the system.

**Save Settings** – Allows you to save the current settings to an attached USB flash drive.

**Init Preset Names** – Initializes all of the preset names in the system to their default names: “Preset 001”, “Preset 002”, etc. The numbering of these names starts with the global preset offset, which can be set in the main setup menu.

**System Info** – Displays the versions of the firmware currently installed on the system as well as the electronic serial number of the Mastermind LT.

**Debug Log** - Displays detailed error messages used to debug the system.

**System Test** - Used at the factory to verify that the Mastermind LT is working properly.

**Factory Reset** – Erases the memory of the Mastermind LT and restores all settings to the factory defaults.

**Update Firmware** – Begins the firmware update process. Please refer to the Updating Firmware section for more information.

### Expression Pedal Menu

The Expression Pedal menu allows you to edit the behavior of the expression pedal. This menu can be accessed from the Main Menu, which is where you set the global expression pedal settings. You can also enter this menu from Edit Presets, which allows you to override the global settings for a preset.

**Override** – This parameter is only visible when editing the expression pedal settings for a particular preset (not from the Main Menu). When editing a preset, turn this parameter **On** to override the global settings for the expression pedal. The remainder of the settings below will be displayed so you can edit the expression pedal settings for the current preset.

**Name** - Allows you to name the expression pedal.

**SndOnPrst** – Turning this on makes the expression pedal send its current CC value(s) every time you change to a new preset. This parameter is only available in the global expression pedal menu.

**Calibrate** – Enters pedal calibration. You are asked to move the pedal all the way up and all the way down. This insures that the pedal will work optimally with the Mastermind LT. Press the **Done** soft button when you are finished. This parameter is only available when editing the global pedal parameters from the Main Menu.

**Device** – Selects the device this pedal will control. Uses the Device Select Menu to allow you to choose from the defined devices.

**CC Number** – Allows you to edit the continuous controller number sent by the pedal.

**Min Val** – Sets the value sent by the expression pedal when the pedal is raised up all the way.

**Max Val** – Sets the value sent by the expression pedal when the pedal is pushed all the way down.

**Assign CC** – This button allows you to choose a continuous controller from the list of functions defined for each device. When this button is selected, you are prompted for one of the functions available on the device. The continuous controller number associated with that function is to the CC Number parameter, and default values are filled in for Min Val and Max Val.

**Device 2, CC Number 2, Min Val 2, Max Val 2 and Assign CC 2** – These parameters allow you to set up the expression pedal to control a second CC parameter at the same time as it controls the first CC. This is particularly useful for cross-fading, where one parameter decreases while the another parameter increases (and vice-versa).

**Set Switch** – Sets the expression pedal's switch point to the current pedal position. Please refer to the Expression Pedal section for more details.

**Switch Invert** – Inverts the sense of the expression pedal position switch. Please refer to the Expression Pedal section for more details.

## Specifications

<b>Dimensions</b>	11.5 (W) x 5.0 (D) x 2.75 (H) inches / 29.2 x 12.7 x 7.0 cm
<b>Weight</b>	1.9 lbs / 0.86kg
<b>Power</b>	9VDC or 12VDC 200mA 5.5mm OD, 2.1mm ID x 9.5mm barrel connector ( <i>BOSS-style</i> ) Either polarity <b>Note:</b> use one of the two Line 6 outputs on Voodoo Lab Pedal Power 2+, or one of the 400mA outputs on the larger Pedal Power products.

# Mastermind LT MIDI Implementation Chart

MIDI Implementation Chart v 2.0 (Page 1 of 3)			
Manufacturer: RJM Music Technology, Inc. Model: Mastermind LT Version: 1 Date: December 8, 2016			
	Transmit/Export	Recognize/Import	Remarks
<b>1. Basic Information</b>			
MIDI Channels	1-16	1-16	Channel 1 is set by default
Note Numbers	Yes	No	
Program change	Yes	Yes	
Bank Select Response? (Yes/No)	Yes	Yes	Sends any bank number
If yes, list banks utilized in remarks column			Uses bank MSB and LSB, banks 0-2
Modes supported :			
Mode 1: Omni-On, Poly (Yes/No)	No	No	
Mode 2: Omni-On, Mono (Yes/No)	No	No	
Mode 3: Omni-Off, Poly (Yes/No)	Yes	Yes	
Mode 4: Omni-Off, Mono (Yes/No)	Yes	Yes	
Multi Mode (Yes/No)	No	No	
Note-On Velocity (Yes/No)	Yes	No	
Note-Off Velocity (Yes/No)	Yes	No	
Channel Aftertouch (Yes/No)	No	No	
Poly (Key) Aftertouch (Yes/No)	No	No	
Pitch Bend (Yes/No)	No	No	
Active Sensing (Yes/No)	No	No	
System Reset (Yes/No)	No	No	
Tune Request (Yes/No)	No	No	
Universal System Exclusive:			
Sample Dump Standard (Yes/No)	No	No	
Device Inquiry (Yes/No)	No	No	
File Dump (Yes/No)	No	No	
MIDI Tuning (Yes/No)	No	No	
Master Volume (Yes/No)	No	No	
Master Balance (Yes/No)	No	No	
Notation Information (Yes/No)	No	No	
Turn GM1 System On (Yes/No)	No	No	
Turn GM2 System On (Yes/No)	No	No	
Turn GM System Off (Yes/No)	No	No	
DLS-1 (Yes/No)	No	No	
File Reference (Yes/No)	No	No	
Controller Destination (Yes/No)	No	No	
Key-based Instrument Ctrl (Yes/No)	No	No	
Master Fine/Coarse Tune (Yes/No)	No	No	
Other Universal System Exclusive	No	No	
Manufacturer or Non-Commercial System Exclusive	Yes	Yes	RJM Music Technology, Inc. Manuf. ID: 00 01 5B
NRPns (Yes/No)	No	No	
RPN 00 (Pitch Bend Sensitivity) (Yes/No)	No	No	
RPN 01 (Channel Fine Tune) (Yes/No)	No	No	
RPN 02 (Channel Coarse Tune) (Yes/No)	No	No	
RPN 03 (Tuning Program Select) (Yes/No)	No	No	
RPN 04 (Tuning Bank Select) (Yes/No)	No	No	
RPN 05 (Modulation Depth Range) (Yes/No)	No	No	
<b>2. MIDI Timing and Synchronization</b>			
MIDI Clock (Yes/No)	No	No	
Song Position Pointer (Yes/No)	No	No	
Song Select (Yes/No)		No	
Start (Yes/No)	No	No	
Continue (Yes/No)	No	No	
Stop (Yes/No)	No	No	
MIDI Time Code (Yes/No)	No	No	
MIDI Machine Control (Yes/No)	No	No	
MIDI Show Control (Yes/No)	No	No	
If yes, MSC Level supported			
<b>3. Extensions Compatibility</b>			
General MIDI compatible? (Level(s)/No)	No	No	
Is GM default power-up mode? (Level/No)	No	No	
DLS compatible? (Levels(s)/No)	No	No	
(DLS File Type(s)/No)	No	No	
Standard MIDI Files (Type(s)/No)	No	No	
XMF Files (Type(s)/No)	No	No	
SP-MIDI compatible? (Yes/No)	No	No	



MIDI Implementation Chart v 2.0 (Page 2 of 3)

Manufacturer: RJM Music Technology, Inc. Model: Mastermind LT Version: 1 Date: December 8, 2016

Control #	Function	Transmitted (Y/N)	Recognized (Y/N)	Remarks
0	Bank Select (MSB)	Y	Y	
1	Modulation Wheel (MSB)	Y	N	
2	Breath Controller (MSB)	Y	N	
3		Y	N	
4	Foot Controller (MSB)	Y	N	
5	Portamento Time (MSB)	Y	N	
6	Data Entry (MSB)	Y	N	
7	Channel Volume (MSB)	Y	N	Exp pedal default
8	Balance (MSB)	Y	N	
9		Y	N	
10	Pan (MSB)	Y	N	
11	Expression (MSB)	Y	N	
12	Effect Control 1 (MSB)	Y	N	
13	Effect Control 2 (MSB)	Y	N	
14		Y	N	
15		Y	N	
16	General Purpose Controller 1 (MSB)	Y	N	
17	General Purpose Controller 2 (MSB)	Y	N	
18	General Purpose Controller 3 (MSB)	Y	N	
19	General Purpose Controller 4 (MSB)	Y	N	
20		Y	N	
21		Y	N	
22		Y	N	
23		Y	N	
24		Y	N	
25		Y	N	
26		Y	N	
27		Y	N	
28		Y	N	
29		Y	N	
30		Y	N	
31		Y	N	
32	Bank Select (LSB)	Y	Y	
33	Modulation Wheel (LSB)	Y	N	
34	Breath Controller (LSB)	Y	N	
35		Y	N	
36	Foot Controller (LSB)	Y	N	
37	Portamento Time (LSB)	Y	N	
38	Data Entry (LSB)	Y	N	
39	Channel Volume (LSB)	Y	N	
40	Balance (LSB)	Y	N	
41		Y	N	
42	Pan (LSB)	Y	N	
43	Expression (LSB)	Y	N	
44	Effect Control 1 (LSB)	Y	N	
45	Effect Control 2 (LSB)	Y	N	
46		Y	N	
47		Y	N	
48	General Purpose Controller 1 (LSB)	Y	N	
49	General Purpose Controller 2 (LSB)	Y	N	
50	General Purpose Controller 3 (LSB)	Y	N	
51	General Purpose Controller 4 (LSB)	Y	N	
52		Y	N	
53		Y	N	
54		Y	N	
55		Y	N	
56		Y	N	
57		Y	N	
58		Y	N	
59		Y	N	
60		Y	N	
61		Y	N	
62		Y	N	
63		Y	N	

MIDI Implementation Chart v 1.0 (Page 3 of 3)

Manufacturer: RJM Music Technology, Inc. Model: Mastermind LT Version: 1 Date: December 8, 2016

Control #	Function	Transmitted (Y/N)	Recognized (Y/N)	Remarks
64	Sustain Pedal	Y	N	
65	Portamento On/Off	Y	Y	Fn Switch 1 on/off (dflt)
66	Sostenuto	Y	Y	Fn Switch 2 on/off (dflt)
67	Soft Pedal	Y	N	
68	Legato Footswitch	Y	N	
69	Hold 2	Y	N	
70	Sound Controller 1 (default: Sound Variation)	Y	N	
71	Sound Controller 2 (default: Timbre / Harmonic Quality)	Y	N	
72	Sound Controller 3 (default: Release Time)	Y	N	
73	Sound Controller 4 (default: Attack Time)	Y	N	
74	Sound Controller 5 (default: Brightness)	Y	N	
75	Sound Controller 6 (GM2 default: Decay Time)	Y	Y	Page select (default)
76	Sound Controller 7 (GM2 default: Vibrato Rate)	Y	N	
77	Sound Controller 8 (GM2 default: Vibrato Depth)	Y	N	
78	Sound Controller 9 (GM2 default: Vibrato Delay)	Y	N	
79	Sound Controller 10 (GM2 default: Undefined)	Y	N	
80	General Purpose Controller 5	Y	N	
81	General Purpose Controller 6	Y	N	
82	General Purpose Controller 7	Y	N	
83	General Purpose Controller 8	Y	N	
84	Portamento Control	Y	N	
85		Y	N	
86		Y	N	
87		Y	N	
88		Y	N	
89		Y	N	
90		Y	N	
91	Effects 1 Depth (default: Reverb Send)	Y	N	
92	Effects 2 Depth (default: Tremolo Depth)	Y	N	
93	Effects 3 Depth (default: Chorus Send)	Y	N	
94	Effects 4 Depth (default: Celeste [Detune] Depth)	Y	N	
95	Effects 5 Depth (default: Phaser Depth)	Y	N	
96	Data Increment	Y	N	
97	Data Decrement	Y	N	
98	Non-Registered Parameter Number (LSB)	Y	N	
99	Non-Registered Parameter Number(MSB)	Y	N	
100	Registered Parameter Number (LSB)	Y	N	
101	Registered Parameter Number(MSB)	Y	N	
102		Y	N	
103		Y	N	
104		Y	N	
105		Y	N	
106		Y	N	
107		Y	N	
108		Y	N	
109		Y	N	
110		Y	N	
111		Y	N	
112		Y	N	
113		Y	N	
114		Y	N	
115		Y	N	
116		Y	N	
117		Y	N	
118		Y	N	
119		Y	N	
120	All Sound Off	Y	N	
121	Reset All Controllers	Y	N	
122	Local Control On/Off	Y	N	
123	All Notes Off	Y	N	
124	Omni Mode Off	Y	N	
125	Omni Mode On	Y	N	
126	Poly Mode Off	Y	N	
127	Poly Mode On	Y	N	

